

Crestpoint ROUNDS®

JUNE
2020
Volume 4
Issue 2

PUBLISHED FOR ALL OPHTHALMIC AUDIENCES: SURGEONS, YOUNG EYE SURGEONS, NURSES/TECHNICIANS AND PURCHASING TEAMS

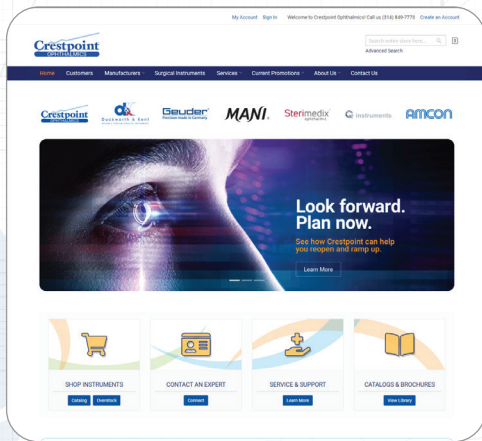

Cataract Sets—What's on your tray?

In this issue we are highlighting the necessities when performing Cataract Surgery — featuring the finest quality surgical instruments from Duckworth & Kent® and Geuder®.

Crestpoint Ophthalmics is the USA Distributor for

- Duckworth & Kent® Titanium Surgical Instruments
- GEUDER® Handheld Instruments
- Mr. Phaco®/Mr. Femto®
- MANI® Knives and Sutures
- Sterimedix®
- Q instruments



Download our Catalog!

New Crestpoint Website!

We're pleased to announce our new E-Commerce website is online and in service! New features for faster product selection and quotes. [Click here.](#)

Crestpoint ROUNDS®—published for all ophthalmic audiences: surgeons, young eye surgeons, nurses/technicians, and purchasing teams. Our mission is to keep the Ophthalmic Community informed by highlighting the best of the best product solutions that enhance the efficiency of ophthalmic surgical techniques.



MANI® Single-Use Disposable Ophthalmic Knives

MANI®'s exclusive bevel shape (patented), crosslapped edge, and high-strength stainless steel construction produce the "Ultimate Sharpness" for a true, stable incision with higher accuracy and lower penetration resistance. Watch the video below.

MANI MST15

Sideport, straight 15°
(Box of 6 knives)

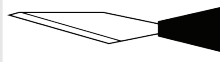

MANI MSL24

Angled, primary incision,
2.4mm (Box of 6 knives)



MANI MVR23A

Angled, 23G (0.9mm)
(Box of 6 knives)

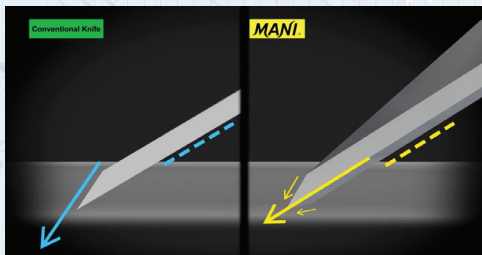
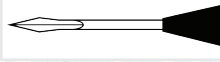

Click for video



Click for video

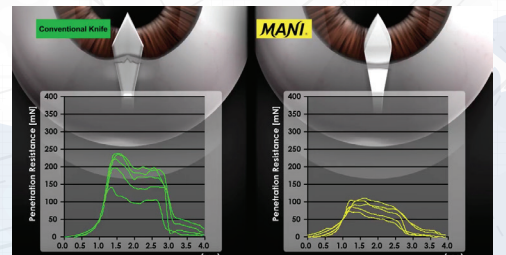

Click for video

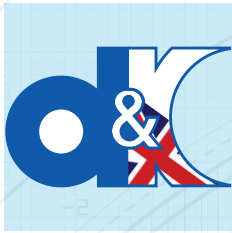

Duckworth & Kent[®] Titanium. Reusable.

Original manufacturer of titanium surgical instruments for ophthalmology and known throughout the world for quality and innovation. D&K titanium instruments are lightweight, non-magnetic, and anodized to reduce glare under the microscope.

Essential CATARACT SET

9-588-3 Lieberman Adjustable Speculum

Temporal, open blades, adjustable, 15.0mm wide.

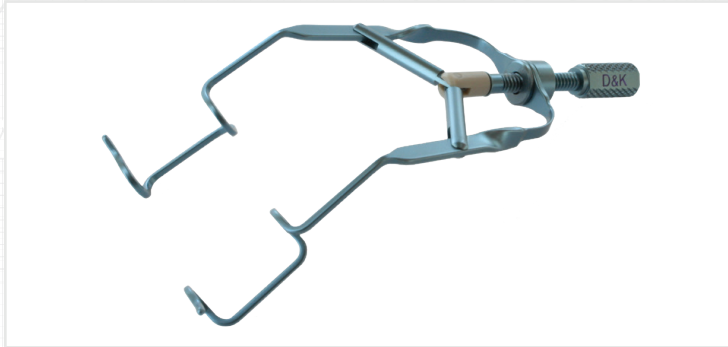

8-652 Irrigation Handpiece

23 gauge/0.65mm tube diameter, two 0.4mm side irrigation ports, curved shaft, round handle.



8-657 Aspiration Handpiece

23 gauge/0.65mm tube diameter, with textured tip, 0.3mm aspiration port, curved shaft, round handle.



2-110E Bonn Suturing Forceps

0.12mm, 1 x 2 teeth, 6.0mm tying platforms, straight shafts.



Sterilizing Trays

T7010 Sterilizing Tray

Holds 10 instruments



T7010-2 Sterilizing Tray

Holds 20 instruments, 2 layers

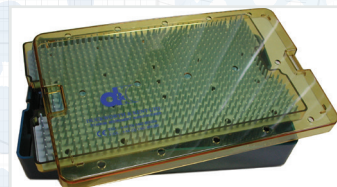

6-085-6 Barrett Double Ended Phaco Axe (Horizontal)

Combo nucleus divider/chopper, nucleus divider blunt end, straight, sharp inner sides, 60° to axis. Chopper, sharp edge base of tip, 45° angled shafts, round handle.

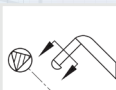

2-716G-10E Jones Inamura Flat Handle Capsulorhexis Forceps

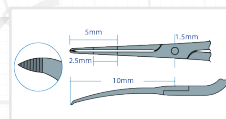

Sharp tips, 1.0mm markings to 6.0mm, curved shafts, tip to pivot 11.0mm, cross action flat handle.

2-716GER8-1 Inamura Capsulorhexis Forceps

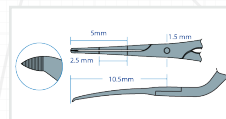

Sharp pointed serrated tips, cross action, curved shaft, tip to pivot 10.5mm.

2-817-1E Salvitti Akahoshi PreChop Forceps

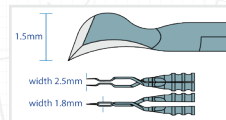

Flattened tips in vertical plane, tip height 1.5mm, 1.8mm maximum width at incision point, straight shafts, reverse cross action style.

2-501E Curved Tying Forceps

6.0mm tying platforms, curved shafts, flat handle.



D&K 7740E IOL Insertion Forceps

Angled shafts, tip to angle length 7.5mm.



3-205 Needle Holder (curved non-locking)

7.0mm medium curved jaws, tag spring.





GEUDER® Chromium Plated Stainless Steel. Reusable.

Leading manufacturer of high quality surgical instruments for ophthalmology, made with chromium plated stainless steel. It has always been the maxim of GEUDER to guarantee the superior level of craftsmanship, precision and reliability.

Geuder Catalog and Scissors Mini-Brochure

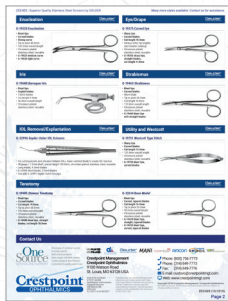

The Geuder instrument catalog is a comprehensive 312 page reference containing 1,400 instruments, specifications, tip illustrations, and instrument sets. Search features include a detailed table of contents, numerical index, keyword index, and name index, available in both PDF and print versions.

The Crestpoint Geuder Scissors Mini-Brochure is a quick reference guide to the most popular items.

G15960 Lieberman-Tennant Speculum

Temporal, open blades, adjustable, 15.0mm.

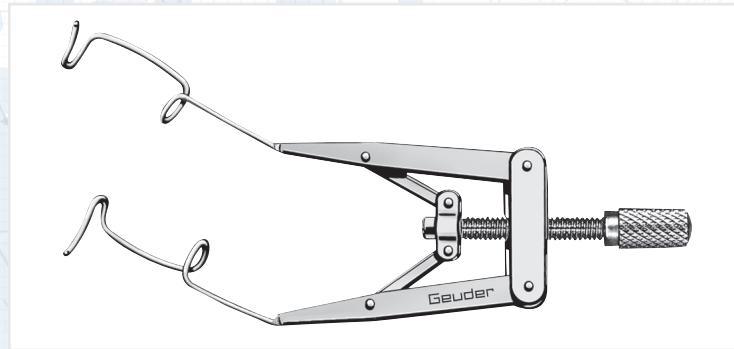

G17500 Barraquer Needle Holder

Delicate 10.0mm curved jaws, tag spring, without lock, round handle.



G31305 Capsulorhexis Forceps

Extra delicate interlocking micro serrated tips, 13.0mm curved shafts, direct action flat handle.



G31720 Akahoshi Prechopper

Pointed tips, open to 3.0mm, straight shafts, cross action.



G16167 Sinskey Lens Manipulation Hook (0.2mm)

0.2mm IOL hole, 10.0mm angled shaft.



G22100 Koch Kohnen Aspiration Handpiece

22 gauge/0.7mm, 0.3mm port, textured tip, curved shaft.

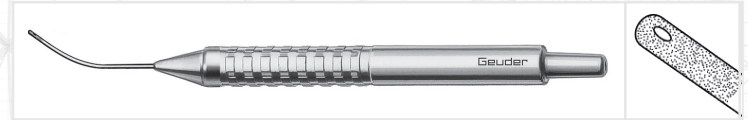

G22101 Koch Kohnen Irrigation Handpiece

22 gauge/0.7mm, front opening, curved shaft.



G19022 Castroviejo Suturing Forceps

0.25mm tip with 0.12mm teeth, 1 x 2 teeth, 6.0mm tying platforms, straight shafts, flat handle.

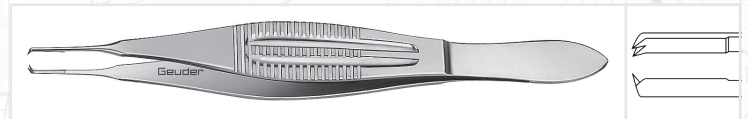

G31901 Holding Forceps

For foldable IOLs, round smooth shaft.



G19032 Tying Forceps

6.0mm tying platforms, 7.5mm angled, flat handle.





STERIMEDIX® Single-Use Disposable

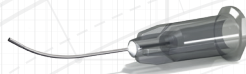

Safety. Quality. Flexibility. Cost efficiency. STERIMEDIX single-use, disposable surgical products meet the demands of modern ophthalmic surgical techniques.

Sterile Packaging Qty 10 / Qty 100 Boxes

STERIMEDIX user-friendly packaging offers the option of boxes with blister pack quantities of either 10 or 100 to make it easier to plan and manage stock status for inventory control.



M2273A Rycroft Anterior Chamber Maintainer

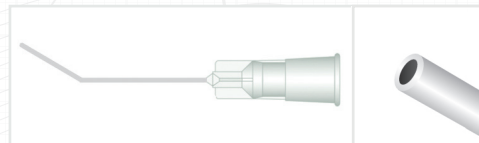

27 gauge x 7/8", angled 35° 4.5mm from tip. Stainless Steel, Disposable. Box of 10.

M2280 Tranzonular Cannula

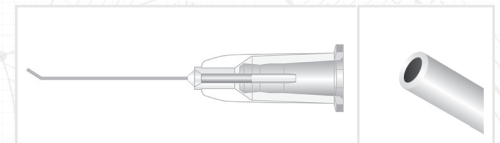

27 gauge, angled 33°, 2.0mm from tip. Stainless Steel, Disposable. Box of 10.

M3912 Mackool Hydrodissection Cannula

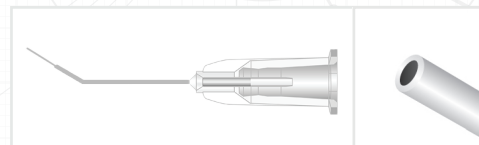

23 gauge x 7/8", 30° angled shaft, 8.0mm from tip, flattened in horizontal plane, 4.0mm from tip. Stainless Steel, Disposable. Box of 10

M3610B Irrigation Cystotome



27 gauge x 5/8", formed. Stainless Steel, Disposable. Box of 10

20\20 Impeccable VISION™

20\20 Impeccable Vision

As we launch into this new decade, we are pleased to unveil our focus: 20\20 Impeccable Vision — and our dedication to saving sight.

One Source® SERVICE AND SUPPORT

Expert service and support.

OneSource® for sales and service, repair-replacement programs, and expert technical support.

Crestpoint OneSource® Service and Support.

We strive to provide our customers with the most **innovative products** and the **finest surgical instruments available**. Our extensive product lines meet each need for every step of your procedures.

Catalogs Available

Click on the catalog links below, Click here to **visit our new website**, Click here to **send us an email**, Or, call us **(800) 756-7773** to request copies.

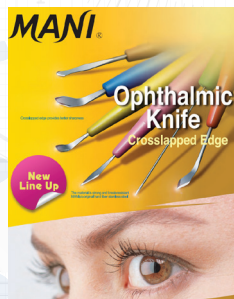
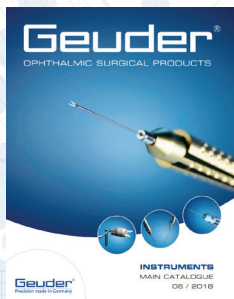

Contact Us

Crestpoint Ophthalmics is dedicated to being the foremost, industry leading, single-source provider of the world's highest quality ophthalmic products.

Our top priority is superb customer service to you.



**Crestpoint Management
Crestpoint Ophthalmics**
9100 Watson Road
St. Louis, MO 63126 USA

GSA/FSS Contract
V797P-4438B
Ophthalmic Instruments
Surgical Devices
SIN A8a & A8b
Effective
5/1/2011 to 4/30/2021

Published by Crestpoint Management. Manufacturer trademarks, part data, and copyrighted materials are property of their respective owners and are used with permission. D&K, Geuder, MANI product ranges in this publication are exclusive in the USA / NA.

Phone: (800) 756-7773
Phone: (314) 849-7773
Fax: (314) 849-7776
E-mail: custsvc@crestpointmgt.com
Website: crestpointophthalmics.com

Copyright 2020 Crestpoint Management / Crestpoint Ophthalmics
All rights reserved. All information in this publication is subject to change without notice.

ZCC483NL (06/2020)

